

0616

by Hidayat Hidayat

Submission date: 16-Apr-2023 11:03PM (UTC+0800)

Submission ID: 2065908955

File name: jeas_0616_4468.pdf (287.78K)

Word count: 3729

Character count: 19893



TIME BASE FIRING PULSE DELAY CONTROL FOR IMPROVING SINGLE PHASE INDUCTION MOTOR SPEED PERFORMANCE USING FUZZY LOGIC CONTROL

Dirman Hanafi¹, Mohd Azkar Sidik¹, Mirza Zoni² and Hidayat²

¹Advanced Mechatronic Research Group, Faculty of Electrical and Electronic Engineering, Universiti Tun Hussein Onn Malaysia, Batu Pahat, Johor, Malaysia

²Electrical Engineering Department, Faculty of Industrial Technology, Universitas Bung Hatta, Padang, Indonesia
E-Mail: dirman@uthm.edu.my

ABSTRACT

This paper focuses on the fuzzy logic controller design for improving the single phase induction motor speed control performance. The controller strategy is done through phase angle control method. The phase angle is controlled by controlling the time base firing pulse angle delay of the triac. Based on experimental results, the fuzzy logic controller is a suitable controller to improve the single phase induction motor speed because it able to reduce the rise time, settling time, peak time and overshoot response to 0.10s, 0.17s, 0.29s and 0.09 % OS respectively. Then compares with the Proportional Integral Derivative (PID) controller responses, the fuzzy logic controller responses are better with the rise time (Tr), the settling time (Ts), the peak time (Tp) and the overshoot (% OS) are 0.08s, 0.08s, 0.05s and 0.004% smaller than PID controller.

Keywords: single phase induction motor speed control, fuzzy logic controller, time base firing pulse delay.

INTRODUCTION

Single phase AC supply plays important roles in electrical usage because it is commonly used for general electrical purpose in domestic or commercial applications where three phase power supply is not available. Based on this supply, single phase induction motors become one of the most widely used for numerous domestic and industrial applications like home appliances, industrial control system, and automation because of their it offer lower maintenance, reliable and smaller motor size. Single phase induction motor has been covered most servo application in robotics, machine tools and positioning devices.

Normally, it has two winding, main and auxiliary. An auxiliary winding has more turns than main winding (Yo, 2000). Traditional single phase induction motor run directly from AC voltage supply at one speed only. The improvement in ac motor control enable the speed of single phase induction motor to be run on variable speed, which can reduce power consumption, acoustic noise and mechanical vibration. The critical aspect in AC motor is the role of the researcher or engineer to control the speed of an AC motor that being used. Traditionally, the AC motor is controlled by two classical strategies, vector control and torque control. Vector control and direct torque control are the two classical strategies to control synchronization and asynchronous of induction motor (Shenand Dai, 2010).

As mention previous, the single phase induction motor is widely use in our daily application because of their ability to operate from a single phase power supply. Since it is impossible to reliably operate at unstable range, simple voltage control (open loop control) is limited to controlling in a narrow range. The speed of the single phase AC induction motor can be adjusted either by applying the proper supply voltage amplitude and

frequency (called volts per hertz) or by the changing of supply voltage amplitude with constant frequency (slip control) (Stekl, 2003). To make it possible to operate reliably even in the unstable range, it is necessary to detect the rotational speed of the motor and use a voltage control mechanism (closed loop control) that reduces the speed error when compared to a set value (Shirataha, 2015).

The speed of induction motor can be control by controlling the voltage applied to the stator voltage. With the enhanced technology in power electronics, a number of semiconductor devices have been introduced in voltage control application. The use of solid state components like the triac for the control of ac drives have been widely used in recent years for several industrial and home applications (Emenike, *et al.*, 2011). The voltage applied to the stator winding of the single phase induction motor can be control to achieve the desired speed by controlling the firing angle of the triac that are used in this work.

For efficient control strategies, the speed of the single phase induction motors need to be controlled properly. The stator voltage controller is needed in order to control the speed. It is because the voltage is directly proportional to the motor speed. For this reason, the phase control technique can be applied for single phase induction motor control. In this technique, a power device known as triac can be used. Triac is a power electronics device which conduct based on the gate pulses it receive rather than the supply voltage (Chee-Hoe, *et al.*, 2013). Triac is connected in series with the motor, and hence by controlling the gate pulse of the Triac, the speed of the induction motor is controlled smoothly and effectively with less power consumption (Kumar, *et al.*, 2013).

Mostly, for closed loop system, conventional or intelligent control techniques were used to provide signal to the firing angle circuit (Emenike, *et al.*, 2011). As the advancement of the technology, the use of intelligent



system to control the induction motor is required because of the traditional controllers does not give the satisfactory results when loading variation condition. In recent years, the artificial intelligent (AI) technique, such as fuzzy logic controller has shown high potential for induction motor application (Rajaji and Kumar, 2008).

RELATED WORKS

Obayed *et al.* (2009) developed a fuzzy logic controller using VHDL for implementation of field programmable logic array (FPGA) to control position through AC motor. Then, the controller is simulated using Altera Quartus 2 version 9.0 software and Matlab software. The controller is able implemented using two software.

Dongale *et al.* (2012) presented the implementation of the controller based on PID and Fuzzy Logic strategies. The controllers are applied to control three phase induction motor. The fuzzy logic control type used in this work is mamdani. The two controllers are simulated using Matlab software. The results shows fuzzy logic control produced better performance.

Mohamed Ramaden *et al.* (2014) proposed the fuzzy logic controller (FLC) to control the speed of a permanent magnet DC motor via a configuration of H-Bridge. The fuzzy logic controller is implemented using Field Programmable Gate Array (FPGA) circuit and the responses are compared with the conventional proportional-integral (PI) controller. The results show that the PI controller performances in the lack of smooth transition between the required speed and the present of overshoot and higher rise time. For the FLC controller, less oscillation, zeros overshoot and less rise time. It means performances of the fuzzy logic controller is better than PI controller.

Mallesham (2007) applied the fuzzy logic controller to control the speed of the electrical machine which is for DC motor and AC motor. In this work, the fuzzy logic controller is designed based on proportional, derivatives and integral fuzzy reasoning. The performance of the fuzzy logic controller is evaluated by simulating using the MATLAB Simulink and the result shows that the proposed controller able to improve the speed control performance of the electric machine.

TRIAC

The triac is a power electronics device that are usually use for ac switching applications because it ability to control the current flow over both halves of an alternating cycle. Several schemes of motor control especially single phase motors are available however the triac control still remains a cheap and an easy method of implementing speed control for many applications (Emenike, *et al.*, 2011).

The main advantage of triac is the device can be used to control the current switching on both halves of an alternating waveform and allows much better power utilization. However the triac is not suitable for some high

power applications where the switching is more difficult. Figure-1 shows the triac symbol for circuit diagram.

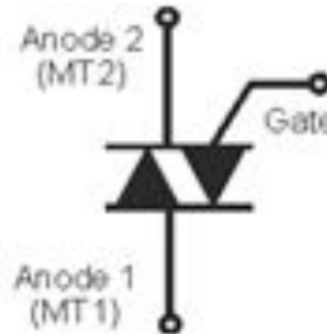

Figure-1. Triac symbol for circuit diagram.

The triac applications are ranging from light dimmers through to various forms of AC control. The triac is driven to change the trigger phase angle for ac voltage, reducing the speed by reducing RMS voltage (Grover and Guy, 2005).

PID CONTROLLER

The most commonly used algorithm for controller design is Proportional-Integral Derivative (PID) and it is most widely used controller in the industry (Hanafi, 2010). It is a closed loop controller. The working principle of PID controller is done by calculating the processed measured value and the desired reference point. The objective of the controller is to minimize the error by changing the inputs of the system. The PID Controller block diagram is shown by Figure-2.

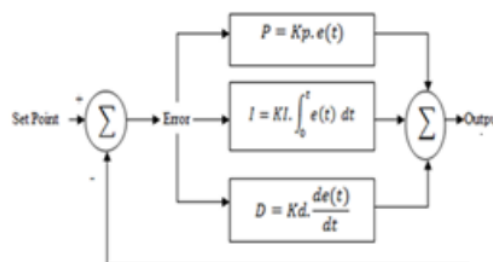

Figure-2. Block diagram of PID controller.

There are 3 parameters for the PID controller measurement which are called the proportional, integral and derivative. The control mechanism such as speed control of a motor is contributed by the summation of the three parts in which P value depend upon current error; I on the accumulation of the previous error and D predict the future error based on current rate change. The output of the control system is given by



$$C(s) = Kp.e(t) + Ki.\int e(t) + Kd.\frac{de(t)}{dt} \quad (1)$$

Based on the equation above, the effect of increasing parameters KP, KI and KD can be explained in Table-1. PID controller has all the necessary dynamics: fast reaction on change of the controller input (D mode), increase in control signal to lead error towards zero (I mode) and suitable action inside control error area to eliminate oscillations (P mode) (Rao and Mishra, 2014).

FUZZY LOGIC CONTROL

Fuzzy Logic was proposed for the first time by LotfiZadeh in 1965. The fuzzy logic controller is the most efficient controller as it handles non linearity and it independent of plant model (Satyanarayana and Srujana, 2012). It has four main components; they are rule base, the inference mechanism, the fuzzification and the defuzzification (Passino, and Yurkovich, 1998).

Fuzzy logic control is easily designed and developed by combining the theoretical infrastructure of the fuzzy logic and real world based control problems. This type of intelligent control systems allows solving control problems via more accurate, effective and efficient logical and mathematical approaches (Kose, 2012). Figure-3 shows a typical fuzzy control system schema (Liu and Abonyi, 2005).

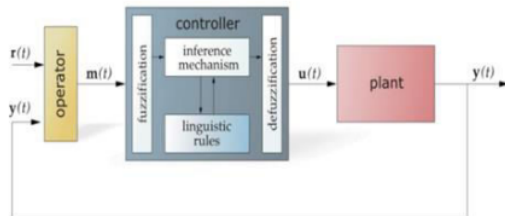

Figure-3. A typical fuzzy control system schema.

Generating the rules for fuzzy control system is often the most difficult step in the design process. It usually requires some expert knowledge of the plant dynamics. This knowledge could be in the form of an intuitive understanding gained from experimenting, or it could come from a plant model which is then used in a computer simulation (Hanafi, 2013).

SISTEM DESIGN

In this work, the fuzzy logic controller is designed to improve the speed control performance of single phase induction motor (SPIM). The fuzzy logic controller controlled the firing pulse delay (α) of the triac.

A. System architecture

Figure-4 illustrates the overall system of the single phase induction motor speed control using fuzzy logic controller. The actual motor speed is compared with the reference speed of the single phase induction motor. The input of the fuzzy logic controller is the error (e) and change of error (ce) and the output of the fuzzy logic controller is the time base firing pulse delay (α).

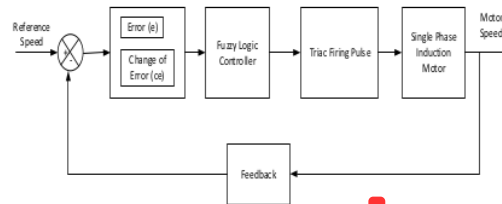

Figure-4. Block diagram overall the single phase induction motor speed control using fuzzy logic controller.

B. Design of fuzzy logic controller

Based on Figure-3, the fuzzy logic controller is composed based on 4 elements which are the Fuzzification, Rule Base, Fuzzy Inference System and Defuzzification.

a) Define input and output variables

The input variables of the fuzzy logic controller for this purpose are the error (e) and the change of error (ce). The output variable is the firing pulse delay (α). The error (e) variable is determined by the difference between the reference speed (ω_{ref}) and the actual speed of the motor (ω_{act}). The change of error variable contributes to the inference mechanism by providing the information about the change of the single phase induction motor speed. The value of the change of error (ce) is measured by the difference between the previous error and the current error. The error (e) and the change of error (ce) are given by:

$$e(k) = \omega_{ref}(k) - \omega_{act}(k) \quad (2)$$

$$ce(k) = e(k) - e(k-1) \quad (3)$$

b) Membership function and linguistic variables

The second step in the fuzzy logic control is the fuzzification process to convert crisp input into degree of membership for linguistic terms of fuzzy sets.

The fuzzy sets and linguistic terms for error, change of error and firing angle delay are elaborated in the following table.



www.arnjournals.com

Table-1. Input variable error.

Linguistic value	Notation	Range	MF
Negative Big	NB	[-2000 -2000 -1500 -1000]	Trapezoidal
Negative Medium	NM	[-1500 -1000 -500]	Triangular
Negative Small	NS	[-1000 -500 0]	Triangular
Zero	Z	[-500 0 500]	Triangular
Positive Small	PS	[0 500 1000]	Triangular
Positive Medium	PM	[500 1000 1500]	Triangular
Positive Big	PB	[1000 1500 2000 2000]	Trapezoidal

Table-2. Input variable change of error.

Linguistic value	Notation	Range	MF
Negative Big	NB	[-1500 -1500 -1125 -750]	Trapezoidal
Negative Medium	NM	[-1125 -750 -375]	Triangular
Negative Small	NS	[-750 -375 0]	Triangular
Zero	Z	[-375 0 375]	Triangular
Positive Small	PS	[0 375 750]	Triangular
Positive Medium	PM	[375 750 1125]	Triangular
Positive Big	PB	[750 1125 1500 1500]	Trapezoidal

Table-3. Output variable firing pulse delay.

Linguistic value	Notation	Range	MF
Positive Big	PB	[0 0 0.0015]	Triangular
Positive Medium	PM	[0 0.0015 0.003]	Triangular
Positive Small	PS	[0.0015 0.003 0.0045]	Triangular
Zero	Z	[0.003 0.0045 0.006]	Triangular
Negative Small	NS	[0.0045 0.006 0.0075]	Triangular
Negative Medium	NM	[0.006 0.0075 0.009]	Triangular
Negative Big	NB	[0.0075 0.009 0.009]	Trapezoidal

c) Rule base for the fuzzy logic controller

Rule based is a set of rules that used in fuzzy inference process to evaluate the input and decide the

output. The tabulation of the fuzzy logic control rules develop in this works are as in table below.



Table-4. Triangular membership function for output variable

e ce	NB	NM	NS	Z	PS	PM	PB
NB	NB	NB	NM	NM	NS	NS	ZE
NM	NB	NM	NM	NS	NS	ZE	PS
NS	NM	NM	NS	NS	ZE	PS	PS
Z	NM	NS	NS	ZE	PS	PS	PM
PS	NS	NS	ZE	PS	PS	PM	PM
PM	NS	ZE	PS	PS	PM	PM	PB
PB	ZE	PS	PS	PM	PM	PB	PB

d) Defuzzification method

The last process is fuzzification, where the inference process output is converted again into crisp. One of the well-known method is a centre of area (CoA) and represented as

$$CoA = \frac{\sum_{k=0}^{k=N} x_k \mu(x_k)}{\sum_{k=0}^{k=N} \mu(x_k)} \quad (4)$$

x_k = value in universe of discourse

$\mu(x_k)$ = degree of membership related with x_k

C. Implementation of the fuzzy logic controller model

The Simulink block diagram of the fuzzy logic controller to control the speed of the single phase induction motor speed by controlling the firing angle delay of triac is illustrated by Figure-5.

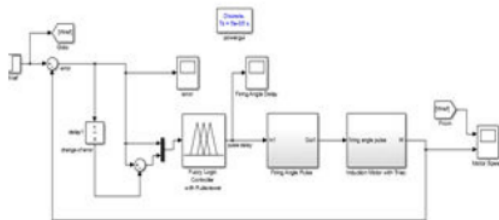

Figure-5. Fuzzy logic controller model in Simulink.

a) Firing pulse subsystem

The operation of the triac is basically related on the firing pulse delay that connected to the triac gate. When the pulse is enabled, the current will flow through the triac and the single phase induction motor. The stator voltage value is reduced by increase the delay of the triac angle pulse. Figure-6 illustrate the Simulink model of the firing pulse delay subsystem of this project.

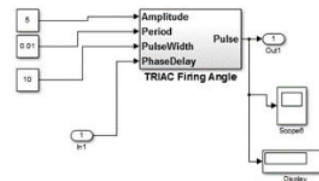

Figure-6. Triac firing pulse subsystem.

The subsystem model to generate the required time base pulse angle to the triac gate to control the voltage input of the single phase induction motor is shown by Figure-7.

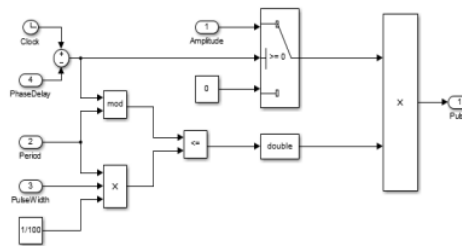

Figure-7. Pulse generating model.

b) Single phase induction motor and triac circuit connection.

The connection circuit between triac and the single phase induction motor is represented by Figure-8.

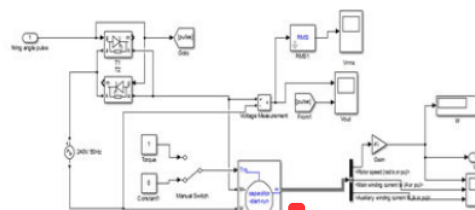

Figure-8. Simulink model for single phase induction motor with triac.



The data of the single phase induction motor used in this test are described in table below.

Table-5. Single phase induction motor parameters.

Parameter	Value
Reference Speed (ω_{ref})	1500 rpm
Power	0.25 HP
Voltage Supply (V_{rms})	240V
Frequency	50 Hz
Stator Resistance, R_s	2.02 Ohm
Stator Inductance, L_s	7.4 mH
Rotor Resistance, R_r	4.02 Ohm
Rotor Inductance, L_r	5.6 mH
Main winding mutual inductance	0.1772 H
Auxiliary winding resistance, R_S	4.12 Ohm
Auxiliary winding inductance, L_S	8.5 mH

RESULT AND ANALYSIS

The two controllers are used in experiments based on the single phase induction motor data previous. The speed reference for the single phase induction motor is 1500 rpm. The best firing pulse time delay and each controller responses are as Figure below:

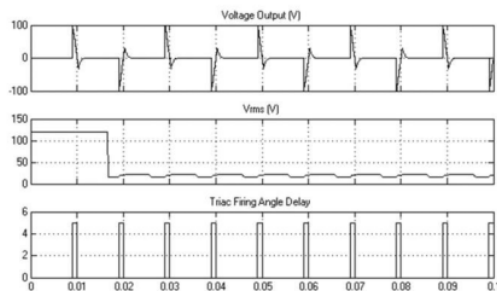

Figure-9. The best firing pulse time delay for triac gate.

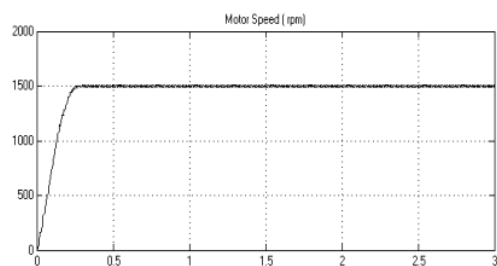

Figure-10. The PID controller best response.

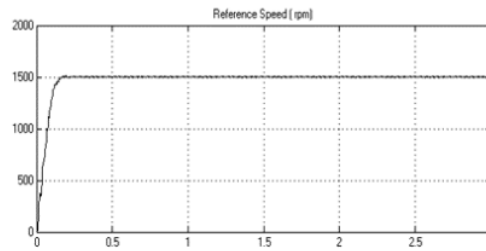

Figure-11. The fuzzy logic controller best response.

The comparison of the two controller's responses parameters are elaborated in below.

Table-6. Comparison between PID Control and Fuzzy Logic Control response parameters.

Parameter	PID	FLC	Differences
Rise Time	0.18s	0.10s	0.08s
Settling Time	0.25s	0.17s	0.08s
Peak Time	0.34s	0.29s	0.05
Percent Overshoot	0.1%	0.096 %	0.004%

Based on data in Table-6 above, the fuzzy logic controller gives better performance than PID controller. The fuzzy logic controller has faster rise time and settling time and also lower overshoot.

CONCLUSIONS

From the experiments show that the fuzzy logic controller produced better response than the PID controller. The fuzzy logic controller gives shorter rise time (T_r), settling time (T_s), peak time (T_p) and lower overshoot (% OS), they are 0.08s, 0.08s, 0.05 and 0.004 % respectively. Therefore, the proposed fuzzy logic controller is a suitable controller for single phase induction motor.

ACKNOWLEDGEMENT

This research has been supported by Registrar Office and RACE Grant of Office of Research Innovation Commercialization and Consultancy (ORICC) Universiti Tun Hussein Onn Malaysia under project vot. no. 1439.

REFERENCES

Chee-Hoe, P., Jer-Vui, L., Yea-Dat, C., Yong-Chai, T. and Debnach, N. 2013. Design of a Microcontroller Based Fan Motor Controller for Smart Home Environment. International Journal of Smart Home, 7(4). pp. 233-246.

Dongale, T.D., Jadhav, S.R., Kulkarni, S.V., Kulkarni, T.G., Mudholkar, R.R. and Uplane, M.D. 2012. Performance Comparison of PID and Fuzzy Control Technique in Three Phase Induction Motor Control.



International Journal on Recent Trend in Engineering and Technology, 7(2). pp. 271-275.

Emenike, O.I., C.V, Aravin, C.V. and Gobbi, R. 2011. An Investigation of Closed Loop Control of Single Phase Induction Motors Using Industrial Components. IEEE Conference on Sustainable Utilization and Development in Engineering and Technology (STUDENT). pp. 1-6.

Grover, L. and Guy, J. 2005. Closed Loop Control Benefit AC Motor, Aircare Automation, Austin, Texas. Power Electronics Technology. pp. 18-22.

Hanafi, D., Mohd-Abueejela, Y. and Zakaria, M.F. 2013. Wall Follower Autonomous Robot Development Applying Fuzzy Incremental Controller, Scientific Research, Intelligent Control and Automation 2013, 4(1). pp. 18-25.

Hanafi, D. 2010. PID Controller Design for Semi-Active Car Suspension Based on Model from Intelligent System Identification. The 2nd International Conference on Computer Engineering and Application. pp. 60-63.

Kose, U. 2012. Fundamental of Fuzzy Logic with and Easy-to-use, Interactive Fuzzy Control Application. International Journal of Modern Engineering Research (IJMER), 2(3). pp. 1198-1203.

Kumar, Y.V.N., HimaBindu, P. H., Sneha, A. D. and Sravani, A. 2013. Novel Implementation of Phase Control Technique for Speed Control Induction Motor using ARDUINO. International Journal of Emerging Technology and Advanced Engineering, 3(4). pp. 469-473.

Liu, D.H.F. and Abonyi, J. 2005. Software for Fuzzy Logic Control. Unpublished.

Mallesham, G. 2007. Improvement in Dynamic Response of Electrical Machine with PID and Fuzzy Logic Based Controller. The World Congress on Engineering and Computer Science (WCECS 2007).

Obaid, Z. A., Sulaiman, N. and Hamidon, M.N. 2009. Design of Fuzzy Logic Controller for AC Motor Based on Field Programmable Gate Array. The 2009 IEEE Student Conference on Research and Development (SCORED 2009). pp. 487-490.

Passino, K. M. and Yurkovich, S. 1998. Fuzzy Control. Addison Wesley.

Rajaji, L. and Kumar. C. 2008. Adaptive Neuron Fuzzy Based Soft Starting of Voltage Control Induction Motor Drive. Southeastcon IEEE. pp. 448-453.

Ramadan, E.A.E.M., El-Bardini, M., El-Rabaie, N.M. and Fkirin, M.A. 2014. Embedded System Based on Real Time Fuzzy Motor Speed Controller. Ain Sham Engineering Journal, 5. pp. 399-409.

Rao K.S. and Mishra, R. 2014. Comparative Study of P, PI and PID Controller for Speed Control of VSI-Fed Induction Motor, International Journal Engineering Development and Research (IJEDR), 2(2). pp. 2740-2744.

Satyanarayana, Y. and Srujana, A. 2012. Speed Control of Induction Motor using Fuzzy PI Controller Based on Space Vector Pulse Width Modulation. International Journal of Computational Engineering Research, 2(5). pp. 1203-1209.

Shen, J. and Dai, W. 2010. The Research of Closed Loop Control of AC motor based on J-M transformation control. The 3rd International Conference on Advanced Computer Theory and Engineering (ICACTE). pp. 256-259.

Shirataha, K. 2015. Speed Control Method of Various types of Speed Control Motor. Oriental Motor.

Stekl, P. 2003. Single Phase AC Induction Motor Control Reference Design. Designer Reference Manual Motorola.

Yo, J. 2000. Single Phase Induction Motor Adjustable Speed Control using DSP and Microcontroller. Course Project for ECE734 Fall Semester 2000. UW-Madison.

0616

ORIGINALITY REPORT

24%
SIMILARITY INDEX

20%
INTERNET SOURCES

0%
PUBLICATIONS

14%
STUDENT PAPERS

MATCH ALL SOURCES (ONLY SELECTED SOURCE PRINTED)

20%

★ 1library.net

Internet Source

Exclude quotes On

Exclude matches < 3%

Exclude bibliography On