

# artikel pak dayat 3

*by* Hidayat Hidayat

---

**Submission date:** 20-Jun-2023 04:13PM (UTC+0700)

**Submission ID:** 2119605597

**File name:** Paper020423.pdf (325.24K)

**Word count:** 4402

**Character count:** 21595

# Performance Analysis of Hybrid PID-ANFIS for Speed Control of Brushless DC Motor Base on Identification Model System

Hidayat

Department of Electrical and Information Technology,  
Universitas Gajah Mada  
Department of Electrical, Universitas Bung Hatta  
Padang, Indonesia  
e-mail: hdyttanjung {at} yahoo.com

Sasongko, P.H, Sarjiya, Suharyanto

Department of Electrical and Information Technology,  
Universitas Gajah Mada  
Yogyakarta, Indonesia

**Abstract**— This paper presents a performance of hybrid PID-ANFIS for the speed control of Brushless Direct Current Motor (BLDCM). The model of BLDCM system is determined by identification model system based on the measuring of dynamic response. The aim of the speed controller is to obtain the speed motor operating similar to a speed setting. The controller input is a speed that measured by speed sensor encoder. The controller output is the voltage to supply the stator windings of BLDCM through pulse wide modulation controller to drive inverter. The controller has three input variables: speed error, actual speed, speed setting and output variable is the signal to determine the voltage value. There are two controller structures to analyze the performance of hybrid PID ANFIS controller. The first, output of PID controller is as a main control and the output of ANFIS controller is as a recovery control which switched base on speed error. The second, output of PID controller is added by the output of ANFIS controller. Using MATLAB Simulink, the performance analysis is emphasized on the transient parameter of dynamic response. The simulation results show that the best response of speed control is switched from PID to ANFIS controller at the speed error less equal 10 %.

**Keywords**- BLDCM, speed control, Hybrid PID-ANFIS

## I. INTRODUCTION

BLDCM have been widely used as motor motion recently, because BLDCM has advantage than other motors, such as the efficiency is more 13 % than induction motor, the volume is less 40 % than conventional DC motor [1],[2]. The other advantages, caused no brush so they require little or no maintenance, they generate less acoustic and electrical noise than conventional DC motor, they can be used in hazardous operation environments (with flammable products)[3]. Therefore, many BLDCM had been applied in the industry. industrial drives ex pump, fans, blower, machine tools, servo drives, automation process, internal transportations systems, robots, etc), the public life (e.g. air conditioning systems, catering equipment, coin laundry machines, auto bank machine, etc), the domestic life (kitchen equipment e.g. refrigerators, microwave ovens, mixer, bathroom equipment, washing machines, toys, vision and sound equipment, security systems, etc), information and office equipment (e.g.

computers, printers, plotters, scanners, etc), medical and healthcare equipment (e.g. dentist's drills, electric wheelchairs, trolleys, rehabilitation equipment, artificial heart motors) and etc [1]. To control the speed of BLDCM, Atmel Corporation have produced the BLDCM using ATmega32M1 which applies a classic control. It is PID control. A quality control of BLDCM depends on the PID constant that is Kp, Ki, Kd. Tune Kp, Ki, Kd is done using the trial and error method [3]. Modeling of BLDCM is needed to design and analyze the performance the speed controller which can be obtained easily by the identification parameter [4]

In recent years, new artificial intelligent-based approaches have been proposed for speed control of BLDCM fuzzy logic controller has been applied, which results still show an oscillation on steady state response. Furthermore, to decide on the domain of membership function is more difficult to be done [5],[6]. The speed response of BLDCM that uses to ANFIS controller which apply the several functions and number of membership functions. The best response is obtained on the bell function and five membership functions. To prove the speed response of BLDCM, applied parallel fuzzy PID controller which consists of three parallel fuzzy sub controllers that update online the values of the proportional, integral, and derivative gains. The controller input is the speed error and the delayed control signal that represented to triangle functions [8].

In this paper, a systematic approach for designing hybrid PID-ANFIS is developed to find the best speed response of BLDCM. The model of BLDCM base on identification model system which is determined by dynamic response system. To analyse a performance of controller is done by several control structures i.e. PID controller, ANFIS controller, hybrid PID ANFIS. The hybrid PID-ANFIS is divided in to two structures that are a summing PID and ANFIS output controller and a selecting PID and ANFIS output controller.

The control input of ANFIS controller are actual speed and speed setting that represented by the bell function. The input of PID controller is the speed error and PID constant determined by the close loop Ziegler Nichols method.

10  
II. BLDCM MODELLING

BLDCM is constructed of Permanent Magnet Synchronous Machine (PMSM) 3 phase star connection, 2 poles, inverter 3 phase voltage source inverter, rectifier, filter, rotor position sensor, speed sensor and algorithm control [9],[10]. The equipment of BLDCM is represented in Fig.1. The AC source is rectified to be source of inverter 1 phase, which derives the PMSM. As can be seen, rotor position is an input to the controller. Based upon rotor position and other input, the controller determines the switching states of each of the inverter semiconductors. The command signal to the controller may be quite varied depending upon structure the controls in the system in which the drive is embedded. Other inputs to the control the algorithms may include rotor speed, dc link voltage, and rectifier.

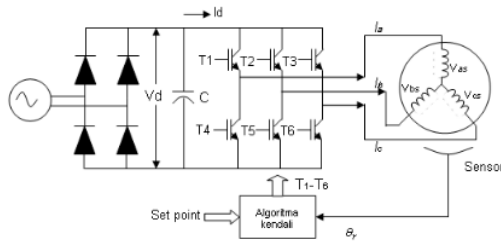

Fig.1 The circuit element of BLDCM [9]

A. BLDCM Modeling Base on Transfer Function of each Element

This model is based on the each element of BLDCM which refers to Fig.1 that discussed and given in [11]. Block schematic of speed control system of BLDCM that represents PI controller, driver (inverter 3 phase), speed sensor and PMSM is given by Fig.2.

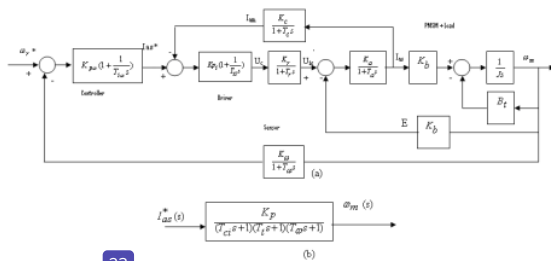

Fig.2. a. Block schematic of speed control system of BLDCM [11]

b. Simply block schematic of speed control system of BLDCM

The simply block schematic of speed control system represents the open loop transfer function of BLDCM without controller represented, as in

$$\frac{\omega_m}{I_{as}^*} = \frac{K_p}{(T_{ci}s + 1)(T_t s + 1)(T_{as}s + 1)} \quad (1)$$

where,

$$K_{ci} = 1/K_c, T_{ci} = 1/\omega_{ci}$$

$$K_p = K_{ci} K_b K_t, K_t = 1/B_t, T_t = J/B_t$$

B. BLDCM Modeling Base on Identification System

To model BLDCM base on estimation parameter uses an identification system. It is a general term used to describe mathematical tools and algorithms that build dynamical models forms measured data. A dynamical mode in this context is a mathematical description of the dynamic behavior of a system or process that emphasized on the identification of discrete-time transfer function from the measured input and output signal.

A typical discrete-time transfer function is usually given by, as in [12].

$$G(z) = \frac{b_0 z^m + b_1 z^{m-1} + \dots + b_{m-1} z + b_m}{a_1 z^n + a_2 z^{n-1} + \dots + a_n z + a_{n+1}} \quad (2)$$

it corresponds to the difference equation, as in

$$y(t) + a_1 y(t-1) + a_2 y(t-2) + \dots + a_n y(t-n) = b_1 u(t-d) + b_2 u(t-d-1) + \dots + b_m u(t-d-m+1) + \varepsilon(t) \quad (3)$$

where  $\varepsilon(t)$  can be regarded identification residual. Here the shorthand notation  $y(t)$  is used for output signal  $y(kT)$ , and  $y(t-1)$  can be used to describe the output at the previous sample, i.e.,  $y[(k-1)T]$ .

$b_i, (i = 1, \dots, m+1)$  dan  $a_i, (i = 1, \dots, n)$ ,  $m \leq n$  are constant,  $z$  discrete variabel and dan  $d$  delay time. Suppose that a set of input and output signals has been measured and written, as in

$$u = [u(1), u(2), \dots, u(M)]^T$$

$$y = [y(1), y(2), \dots, y(M)]^T \quad (4)$$

From equation (3), it can be found that, as in

$$y(1) = -a_1 y(0) - \dots - a_n y(1-n) + b_1 u(1-d) + \dots + b_m u(2-m-d) + \varepsilon(1)$$

$$y(2) = -a_1 y(1) - \dots - a_n y(2-n) + b_1 u(2-d) + \dots + b_m u(3-m-d) + \varepsilon(2)$$

.....

$$y(M) = -a_1 y(M-1) - \dots - a_n y(M-n) + b_1 u(M-d) + \dots + b_m u(M+1-m-d) + \varepsilon(M) \quad (5)$$

where  $y(t)$  and  $u(t)$  assumed to be zero when  $t \leq 0$ . The matrix form of (5) can written as in

$$y = \phi\theta + \varepsilon \quad (6)$$

where

$$\phi = \begin{bmatrix} y(0) & \dots & y(1-n) & u(1-d) & \dots & u(2-m-d) \\ y(1) & \dots & y(2-n) & u(2-d) & \dots & u(3-m-d) \\ \dots & \dots & \dots & \dots & \dots & \dots \\ y(M-1) & \dots & y(M-n) & u(M-d) & \dots & u(M+1-m-d) \end{bmatrix} \quad (7)$$

$$\theta^T = [-a_1, -a_2, \dots, -a_n, b_1, \dots, b_m] \quad (8)$$

$$\varepsilon^T = [\varepsilon(1), \dots, \varepsilon(M)] \quad (9)$$

Minimize the sum of squared residual as in

$$\min_{\theta} \sum_{i=1}^M \varepsilon^2(i) \quad (10)$$

The optimum estimation to the undetermined elements in  $\theta$  can be written as in

$$\theta = [\phi^T \phi]^{-1} \phi^T y \quad (11)$$

Since the sum of squared residual is minimized, the method is also known as the least squares algorithm. The system identification is to identify the discrete-time model from measured input and output data in Matlab toolbox is provide function  $arx()$ . If the measured input and output signals are expressed by column vectors  $u$  and  $y$  the orders of the numerator and denominator as assumed to be  $m-1$  and  $n$ , respectively, and the delay term is  $d$ , the following statement can be used, as in

$$H = arx([y, u], [n, m, d]) \quad (12)$$

In this case, input is speed setting and output is actual speed that can be obtained by measuring dynamic speed respons of BLDCM.

### III. HYBRID PID-ANFIS CONTROLLER MODELLING

#### A. ANFIS Principle

A typical architecture of an ANFIS which is used in Sugeno fuzzy models consist of five layers that every layer has the node. There are two kind of nodes that called the adaptive node (square symbol) and fixed node (circle symbol) as shown in Fig. 3. The mechanism of Sugeno has two inputs  $x_1$  and  $x_2$  and one output  $y$ . For a first-order Sugeno fuzzy model [10],[13], a common rule set with two fuzzy if-then rules is the following, as in

$$\text{If } x_1 \text{ is } A_1 \text{ and } x_2 \text{ is } B_1 \text{ Then } y_1 = c_{11}x_1 + c_{12}x_2 + c_{10} \quad (13)$$

$$\text{If } x_1 \text{ is } A_2 \text{ and } x_2 \text{ is } B_2 \text{ Then } y_2 = c_{21}x_1 + c_{22}x_2 + c_{20} \quad (14)$$

If  $\alpha$  predicate for two roles are  $w_1$  and  $w_2$ , then can be determined the weight average, as in

$$y = \frac{w_1 y_1 + w_2 y_2}{w_1 + w_2} = \bar{w}_1 y_1 + \bar{w}_2 y_2 \quad (15)$$

The function of every layer is:

#### Layer 1

Every node  $i$  in this layer is an adaptive node with a node activation function parameter. The output of every node is the membership function degrees which given by input membership function, as in

$$\alpha_{A1}(x_1), \alpha_{B1}(x_2), \alpha_{A2}(x_1) \text{ or } \alpha_{B2}(x_2).$$

$$O_{1,i} = \mu_{A_i}(x_1), \quad \text{for } i = 1, 2, \text{ or} \quad (16)$$

$$O_{1,i} = \mu_{B_i}(x_2), \quad \text{for } i = 3, 4,$$

If membership function is given by the generalized bell function, as in

$$\mu(x) = \frac{1}{1 + \left| \frac{x-c}{a} \right|^{2b}} \quad (17)$$

where  $\{a, b, c\}$  is the parameter set. As the value of these parameters changes, the bell-shaped function varies accordingly, thus exhibiting various forms of membership functions for fuzzy set  $A$ . Parameters in these layers are referred to as premise parameters.

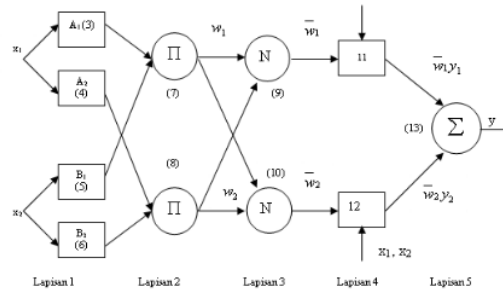

Fig. 3 The architecture ANFIS [10]

24

#### Layer 2

Every node in this layer is fixed node labelled  $\Pi$ , whose output is the product of all the incoming signals, as in

$$O_{2,i} = w_i = \mu_{A_i}(x_1) \mu_{B_i}(x_2), \quad \text{for } i = 1, 2 \quad (18)$$

Each node output represents the firing strength ( $\alpha$  predicate) of a rule. In general, any other T-norm that performs fuzzy AND can be used as the node function in this layer.

#### Layer 3

Every node in this layer is a fixed node labelled  $N$ . The  $i^{\text{th}}$  node calculates the ratio of the gain ratio  $i^{\text{th}}$  rule firing strength ( $\alpha$  predicate) to sum of all rules' firing strengths, as in

$$O_{3,i} = \bar{w}_i = \frac{w_i}{w_1 + w_2}, \quad i = 1, 2 \quad (19)$$

For convenience, outputs of this layer are called normalized firing strengths.

#### Layer 4

Every node  $i$  in this layer is an adaptive node with a node function, as in

$$O_{4,i} = \bar{w}_i y_i = \bar{w}_i (c_{i1}x_1 + c_{i2}x_2 + c_{i0}) \quad i = 1, 2 \quad (20)$$

where  $\bar{w}_i$  is a normalized firing strength from layer 3 and  $\{c_{i1}, c_{i2}, c_{i0}\}$  is the parameter set of this node. Parameters in this layer are referred to as consequent parameters.

#### Layer 5

The single node in this layer is a fixed node labeled  $\Sigma$ , which computes the overall output as the summation of all incoming signals, as in

$$O_{5,i} = \sum_i \bar{w}_i y_i = \frac{\sum_i w_i y_i}{\sum_i w_i} \quad (21)$$

The parameter to be trained are a, b and c of the premise and  $c_{i1}, c_{i2}$  and  $c_{i0}$  of the consequent parameters. ANFIS is trained using hybrid learning algorithm that consists of two steps such as feed forward pass and backward pass. More specifically, in the forward pass of the hybrid learning algorithm, node outputs go to forward until layer 4 and consequent parameters are identified by the least squares method. In the backward pass, the error signal propagates backward and the premise parameters are updated by gradient descent.

### B. ANFIS Controller

The ANFIS base control in this paper is the direct inverse control because of this is simply method and applicable. This method [10] seems straightforward and only one learning task is needed to find the inverse model of the plant, which is not valid in general. Inverse learning or general learning for control purpose is performed in two phases. In the learning phase, the plant ANFIS inverse model is obtained based on input-output data generated from the former ANFIS model of the system as illustrated by Fig. 4. In the application phase, the obtained ANFIS inverse model is used to generate the control action as illustrated by Fig. 5.

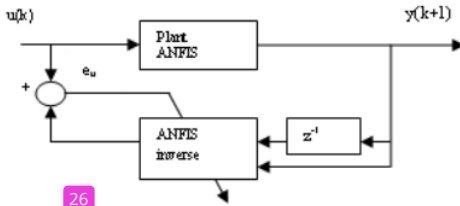

Fig.4. Block diagram a training phase for inverse control method

The ANFIS controller generates change in the reference voltage base on error (e) and derivative error (de). Therefore, the input ANFIS controller is speed error (e) and rate speed error (de). The output controller (u(k)) is suitable signal matching with the input current into stator windings to preserve BLDCM speed similar a setting. Every input and output variables are represented by membership function fuzzy, which domain of membership function is determined by learning process as shown above, as in

$$e = \omega_{ref} - \omega_r = r(k) - y(k+1) \quad (22)$$

$$de = [d(\omega_{ref} - \omega_r)] / dt = y(k) - y(k-1) \quad (23)$$

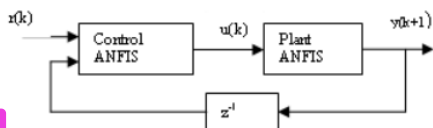

Fig.5. Block diagram an application phase for inverse control method

### C. PID Controller

The PID controller is defined by the following relationship between the controller input (e) and the controller output (u) that is applied to motor armatur, as in [14][15].

$$u = K_p e + K_i \int edt + K_d \frac{de}{dt} \quad (24)$$

To discretise the controller is given as in

$$\frac{du}{dt} = K_p \frac{de}{dt} + K_i \frac{d}{dt} \left( \int e dt \right) + K_d \frac{d^2 e}{dt^2} \quad (25)$$

$$\frac{du}{dt} = K_p \frac{de}{dt} + K_i e + K_d \frac{d}{dt} \left( \frac{de}{dt} \right) \quad (26)$$

the time rate  $\frac{d}{dt}$  is represented by  $\frac{\Delta}{T_s}$  thus:

$$\frac{\Delta U}{T_s} = K_p \frac{\Delta e}{T_s} + K_i e + K_d \frac{\Delta}{T_s} \left( \frac{\Delta e}{T_s} \right) \quad (27)$$

$$\Delta U = K_p \Delta e + K_i e T_s + K_d \Delta \left( \frac{\Delta e}{T_s} \right) \quad (28)$$

the error rate thus:

$$\Delta e = e_n - e_{n-1} \quad (29)$$

$$\begin{aligned} \Delta(e_n - e_{n-1}) &= (e_n - e_{n-1}) - (e_{n-1} - e_{n-2}) \\ &= e_n - 2e_{n-1} + e_{n-2} \end{aligned} \quad (30)$$

The output rate:

$$\Delta U = U_n - U_{n-1} \quad (31)$$

thus,

$$U_n - U_{n-1} = K_p (e_n - e_{n-1}) + K_i e_n T_s + \frac{K_d}{T_s} \Delta(e_n - e_{n-1}) \quad (32)$$

Substituting (30) into (32) are obtained as in

$$U_n = U_{n-1} + K_p (e_n - e_{n-1}) + K_i e_n T_s + \frac{K_d}{T_s} (e_n - 2e_{n-1} + e_{n-2}) \quad (33)$$

where,

$U_n$  : controller output

$e_n$  : error

$T_s$  : time sampling

### D. Hybrid PID-ANFIS Controller

There are two control structures of hybrid PID ANFIS controller that applied respectively;

#### 1) Summing hybrid

This structure, where the controller output adds the PID output and the ANFIS output controller, as represented by (34).

$$U_{HYBRID} = U_{PID} + U_{ANFIS} \quad (34)$$

Flow chart of the summing hybrid structure is shown by Fig.6.

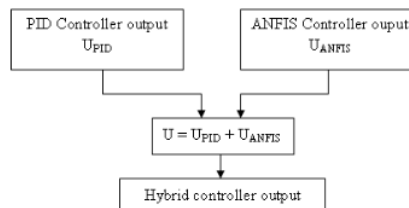

Fig.6. The flow chart of the summing hybrid controller output

2) *Selecting hybrid*

This structure, where the controller output selects the PID output controller and the ANFIS output controller base on persen  $\mu$ , as represented by (35). Three variables are needed to determine the selecting hybrid controller, such as error,  $U_{PID}$  and  $U_{ANFIS}$ . The persen error ( $\Delta E_{Error}$ ) can be determined by trial and error.

$$U_{HYBRID} = \begin{cases} U_{PID}, & \text{for } Error > \Delta E_{Error} \\ U_{ANFIS}, & \text{for } Error \leq \Delta E_{Error} \end{cases} \quad (35)$$

Flow chart of the selecting hybrid structure is shown by Fig.7.

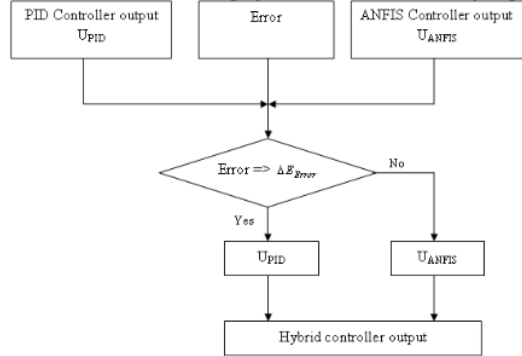

Fig.7. The flow chart of the selecting hybrid controller output

19

IV. SIMULATION AND ANALYSIS

According to the model of ANFIS control systems for BLDCM mentioned above, some vital simulation works have been conducted. Motor model parameters used for simulation is such as:

- Model : ZW60BL120-430
- Voltage : 48 V (DC)
- Arus : 7 A
- Power : 250 W
- Speed : 3000 rpm
- No. : 110325001
- Jenankeya Electron Science And Technology Co. LTD

To determine BLDCM model base on identification model system is needed dynamic speed reponse of BLDCM that showed in Fig. 8. There are three variabels: time (t), actual speed (y(t)), setting speed (u(t)). The series data of Fig.8 is shown in Table 1.

By using MATLAB programming has been given in (12), further obtained the transfer function of BLDCM model, as in

$$TF = \frac{0,05136z + 0,07078}{z^2 - 0,0573z - 0,03198} \quad (36)$$

PID costants  $K_p$ ,  $K_i$  and  $K_d$  are tunned using Ziegler Nichols close loop method [14], further obtained  $K_p = 0,86$ ,  $K_i = 7,2$ ,  $K_d = 0,018$

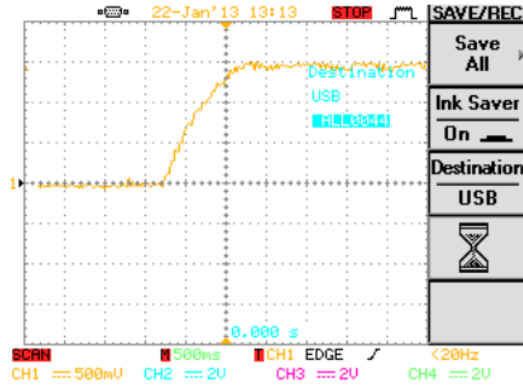

Fig. 8. Dynamic speed reponse of BLDCM

TABLE I. THE SERIES DATA OF DYNAMIC SPEED RESPONSE OF BLDCM

t	y(t)	u(t)	t	y(t)	u(t)	t	y(t)	u(t)	t	y(t)	u(t)	t	y(t)	u(t)	t	y(t)	u(t)
0	0	70	0,56	50	70	1,12	74	70	1,68	73	70	2,24	70	70	2,8	74	70
0,02	-1	70	0,58	49	70	1,14	73	70	1,7	73	70	2,26	72	70	2,82	70	70
0,04	-2	70	0,6	50	70	1,16	75	70	1,72	74	70	2,28	70	70	2,84	71	70
0,06	-2	70	0,62	52	70	1,18	73	70	1,74	74	70	2,3	72	70	2,86	72	70
0,08	2	70	0,64	53	70	1,2	70	70	1,76	72	70	2,32	70	70	2,88	70	70
0,1	5	70	0,66	54	70	1,22	75	70	1,78	73	70	2,34	70	70	2,9	69	70
0,12	6	70	0,68	57	70	1,24	72	70	1,8	74	70	2,36	70	70	2,92	72	70
0,14	6	70	0,7	57	70	1,26	71	70	1,82	73	70	2,38	71	70	2,94	72	70
0,16	11	70	0,72	59	70	1,28	74	70	1,84	73	70	2,4	71	70	2,96	72	70
0,18	14	70	0,74	62	70	1,3	72	70	1,86	74	70	2,42	74	70	2,98	72	70
0,2	14	70	0,76	60	70	1,32	72	70	1,88	73	70	2,44	73	70	3	72	70
0,22	21	70	0,78	61	70	1,34	72	70	1,9	73	70	2,46	74	70	3,02	74	70
0,24	19	70	0,8	62	70	1,36	70	70	1,92	74	70	2,48	74	70	3,04	73	70
0,26	20	70	0,82	61	70	1,38	72	70	1,94	74	70	2,5	74	70	3,06	73	70
0,28	25	70	0,84	66	70	1,4	73	70	1,96	73	70	2,52	73	70	3,08	73	70
0,3	25	70	0,86	67	70	1,42	70	70	1,98	74	70	2,54	74	70	3,1	73	70
0,32	30	70	0,88	65	70	1,44	72	70	2	74	70	2,56	74	70	3,12	74	70
0,34	33	70	0,9	70	70	1,46	71	70	2,02	71	70	2,58	72	70	3,14	74	70
0,36	36	70	0,92	68	70	1,48	74	70	2,04	74	70	2,6	74	70	3,16	73	70
0,38	37	70	0,94	69	70	1,5	71	70	2,06	73	70	2,62	74	70	3,18	73	70
0,4	36	70	0,96	72	70	1,52	73	70	2,08	71	70	2,64	74	70	3,2	74	70
0,42	36	70	0,98	69	70	1,54	73	70	2,1	74	70	2,66	73	70	3,22	74	70
0,44	40	70	1	72	70	1,56	73	70	2,12	72	70	2,68	74	70	3,24	74	70
0,46	44	70	1,02	71	70	1,58	72	70	2,14	71	70	2,7	73	70	3,26	74	70
0,48	45	70	1,04	71	70	1,6	73	70	2,16	73	70	2,72	71	70	3,28	71	70
0,5	46	70	1,06	71	70	1,62	72	70	2,18	69	70	2,74	74	70	3,3	71	70
0,52	45	70	1,08	74	70	1,64	72	70	2,2	71	70	2,76	71	70	3,32	74	70
0,54	46	70	1,1	74	70	1,66	72	70	2,22	73	70	2,78	69	70	3,34	72	70

Three data is needed to train ANFIS, such as two input data and an output data. The input data are actual speed and delay actual speed. The output data is training target that represented by ramp function. It represents speed respon of BLDCM when controller input increased step by step. The data for training are required from the open loop experiment, as shown Fig.9. For the evenly distributed grid points of the time input range 3 second with time sampling 0,001, maximum value 35, and minimum value 0 is obtained 2001 x 3 training data pairs.

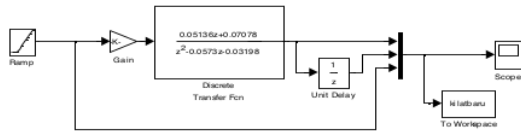

Fig. 9. Learning data of ANFIS controller

The experiment was done by the bell function with 3 membership function for each input and output variables. The ANFIS used here contains 9 (3x3=9) rules, 45 total number of fitting parameters, including 18 (3x3+3x3) premise (non linear) parameters and 27 (3x9=27) consequent (linear) parameters. The training and root mean square (RMSE) errors obtained from the ANFIS are 0,00072442 for 30 epochs. The optimized membership function for input\_1 and input\_2 after trained is shown in Fig. 10.

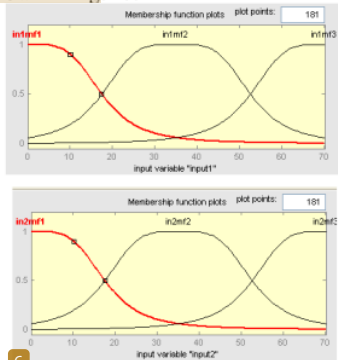

Fig. 10. The membership function for input\_1 and input\_2 after trained.

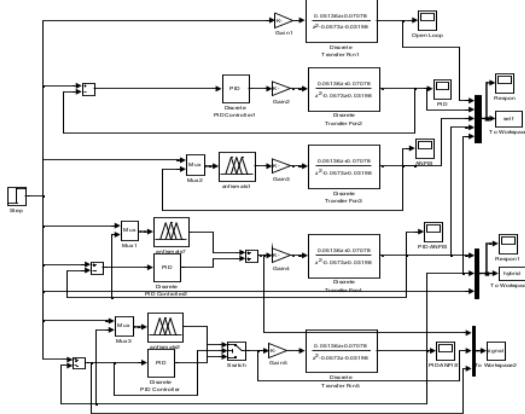

Fig. 11. Simulation circuit of BLDCM speed controller

There are three control structures in this experiment, such as PID, ANFIS and hybrid PID ANFIS controller. The hybrid PID ANFIS consists of a summing output PID and ANFIS controller, a selecting output PID and ANFIS controller.

Selecting the PID and ANFIS output is determined by percent error that done a trial and error method. The simulation circuit of BLDCM speed controller is showed in Fig.11. The simulation is done for a constant speed setting and change speed setting, further determined and evaluated the transient parameter, such as steady state error (error), rise time (tr), delay time (td), over shoot (Mp) and settling time (ts). The first experiment is given the speed setting 2000 rpm and 2500 rpm, further the transient responses of all control structures are shown in Fig. 12 and Fig.13. The transient parameter of BLDCM speed responses for speed setting 2000 rpm were obtained similar to that for speed setting 2500 rpm, as shown in Table II.

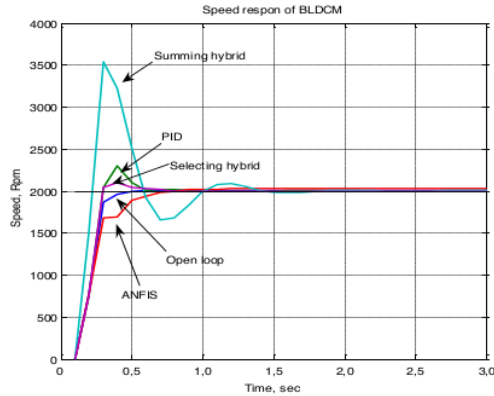

Fig. 12. Speed respon of all control structures for speed setting 2000 Rpm

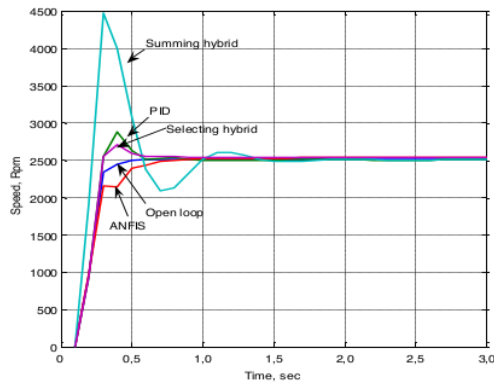

Fig. 13. Speed respon of all control structures for speed setting 2500 Rpm

TABLE II. THE TRANSIENT PARAMETER OF BLDCM SPEED RESPONSE FOR SPEED SET 2000 AND 2500 RPM.

Controller structures	td (sec)	tr (sec)	rs (sec)	Mp (%)	Error (rpm)
PID	0,25	0,3	0,60	12,5	0
ANFIS	0,25	0,4	0,70	0	0
Summing Hybrid PID-ANFIS	0,15	0,20	1,40	75	0
Selecting Hybrid PID-ANFIS	0,25	0,3	0,55	5	0

According to Table II data, it is shown which is the overshoot of summing hybrid PID ANFIS increased 75%, the faster a rise time, the oscillation, the slower the settling time 1,4 second. This is caused by each of the output signal controller to strengthen, so needed a long time to settle.

The transient response of selecting hybrid PID ANFIS for the error less equal 10% was resulted the best response. It has corresponded to what really designed of the selecting hybrid PID ANFIS controller. It has ability to select the output controller accurately.

The second experiment is given the speed setting 1000 rpm, then after 1,5 second it is increased to 2000 rpm which responses is shown in Fig. 14. The speed setting can be followed by actual speed for all control structures although the overshoot of summing hybrid controller is higher than others. It is caused by the output of summing hybrid controller is higher too, which is shown in Fig. 15. The result of speed error is similar to zero.

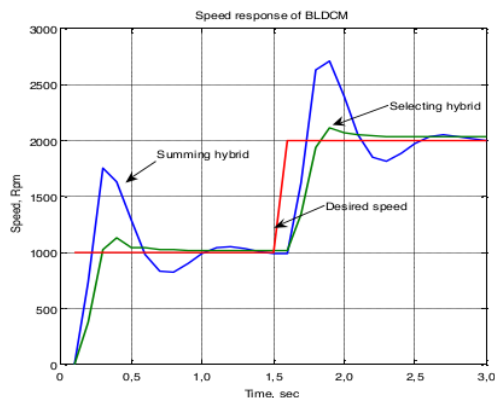

Fig. 14. Speed responses hybrid controller for speed setting changes from 1000 to 2000 rpm

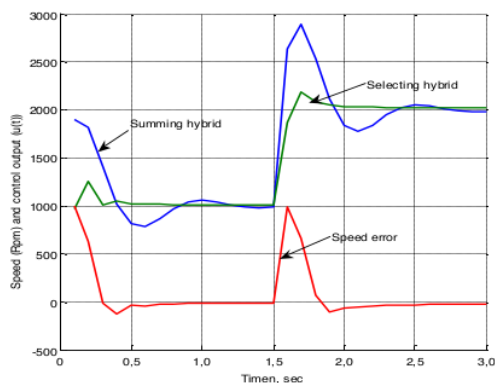

Fig. 15. The control output of hybrid controller for speed setting changes from 1000 to 2000 rpm

## V. CONCLUSION

This paper has described to control the BLDCM speed, that compared the several control structures. The model of BLDCM was constructed by identification system that represented of the real system that obtained to measure the dynamic response system. The hybrid PID ANFIS controller which applied the selecting error was obtained the best response. It was to obtained when the error less equal than 10% the ANFIS controller is done but the error great equal 10% the PID controller is done. Other word, the PID controller is as main control and the ANFIS is as recovery control. The hybrid PID ANFIS controller which applied the summing output PID controller and ANFIS controller can be made the rise time shorter but the overshoot increased.

## REFERENCES

- [1]. Gieras, J.F, Wing.M, Permanent Magnet Motor Technology Design & Application, 2<sup>nd</sup> Edition, Printed USA, London UK, 2002.
- [2]. Hidayat, Sasongko.PH, Srijaya and Suharyanto, "The Speed and Torque Control Strategy of the Brushless DC Machine", CITEE 2010, Yogyakarta.20 Juli 2010.
- [3]. Atmel Corporation, "Brushless DC Motor Control Using ATmega 32M1" April 2008
- [4]. Hidayat, Sasongko.PH, Srijaya and Suharyanto, "Modeling the Speed Control of Brushless DC Machine Base on Identification Model System", Teknos. Padang, vol. 8 pp 60-67, February 2013.
- [5]. Munawar.I, Hidayat, "Design and Implementation Speed Control of the 3 Phase Synchronous Machine to Like Performance of DC Machine Using Fuzzy Logic", SMED 2000, FT UGM, Yogyakarta, 2000.
- [6]. Hidayat, Munawar, I, "Design and Implementation the Speed Control of Brushless DC Machine Using Fuzzy Logic", Thesis Magister Program of Electrical Departement ITB, Bandung, 2000
- [7]. Hidayat, PH.Sasongko, Srijaya & Suharyanto, "Performance Analysis of Adaptive Neuro Fuzzy Inference Systems (ANFIS) for Speed Control of Brushless DC Motor, in Proc. ICEEI 2011, 17-19 July 2011, p. 211.
- [8]. Rubai.A, Marcel J, Castro.S, Abdul R.O, "Design and Implementation of Paralel Fuzzy PID Controller for High-Performance Brushless Motor Drives : An Integrated Enviromenent for Rapid Controln Prototyping" IEEE Transactions on Industry Applications, Vol. 44, No. 4, July/ Agus 2008.
- [9]. Krause, Paul.C, "Analysis of Electric Machinery And Drive Systems", IEEE Press, 2<sup>nd</sup> Edition, USA, 2002.
- [10]. Hidayat, PH.Sasongko, Srijaya & Suharyanto, "Modeling and Simulation of Adaptive Neuro Fuzzy Inference Systems (ANFIS) for Speed Control of Brushless DC Motor", Proc. CITEE 2011, Yogyakarta, 28 Juli 2011, paper E-4-1.
- [11]. Cnosija.P, Krishnan.R, "Transient Performance Base Design Optimation of PM Brushless DC Motor Drive Speed Controller, IEEE ISIE 2005, Dubrovnik, Croatia, June 20-23, 2005, p.881.
- [12]. Xue.D, Chen.Y and Atherton.P.D, "Linier Feedback Control Analysis and Design with MATLAB, Philadelphia, 2007.
- [13]. Jang J-S.R, Sun.C.T, Mizutani.E, "Neuro-Fuzzy and Soft Computing", Prentice-Hall International Inc, USA, 1997
- [14]. Brian, R "The Design of PID Controllers Using Ziegler Nichols Tuning", 2008
- [15]. Khuntia. S.R, Mohanty.KB, S. Panda and C. Ardil, " A Comparative Study of P-I, I-P, Fuzzy and Neuro Fuzzy Controllers for Speed Control of DC Motor Drive" International Journal of Electrical Systems Science and Engineering 1 Januari 2009.



# artikel pak dayat 3

---

## ORIGINALITY REPORT

---

25%

SIMILARITY INDEX

19%

INTERNET SOURCES

20%

PUBLICATIONS

11%

STUDENT PAPERS

---

## PRIMARY SOURCES

---

1	<a href="http://www.rroj.com">www.rroj.com</a> Internet Source	1%
2	Md. Belal Hossen, Bashudeb Chandra Ghosh. "Performance Analysis of a PMBLDC Motor Drive based on ANFIS Controller and PI Controller", 2019 International Conference on Electrical, Computer and Communication Engineering (ECCE), 2019 Publication	1%
3	Denai, M.A.. "Modeling and control of non-linear systems using soft computing techniques", Applied Soft Computing Journal, 200706 Publication	1%
4	"Analysis of Electric Machinery and Drive Systems", Wiley, 2013 Publication	1%
5	<a href="http://epdf.tips">epdf.tips</a> Internet Source	1%
6	Submitted to Birla Institute of Technology Student Paper	1%

7	<a href="http://www.worldscientific.com">www.worldscientific.com</a> Internet Source	1 %
8	<a href="http://ijeee.org">ijeee.org</a> Internet Source	1 %
9	<a href="http://core.ac.uk">core.ac.uk</a> Internet Source	1 %
10	<a href="http://zbook.org">zbook.org</a> Internet Source	1 %
11	Mohammad Reza Abbasi, Ahmad Shamiri, Mohamed Azlan Hussain, Seyed Hamidreza Aghay Kaboli. "Dynamic process modeling and hybrid intelligent control of ethylene copolymerization in gas phase catalytic fluidized bed reactors", Journal of Chemical Technology & Biotechnology, 2019 Publication	1 %
12	Mehmet BAYKARA, Ertan öZNERGİZ, Can öZSOY, Ali DEMİR, Salih GülŞEN. "The Air-Jet Texturing and Twisting Machine's and Model Predictive Control Based on State-Space", IFAC Proceedings Volumes, 2009 Publication	1 %
13	Submitted to Bilkent University Student Paper	1 %
14	Hsieh, Tsung-Che, and Chia-Der Chang. "Using intelligent controller to enhance the walking	1 %

stability of bipedal walking robot", First International Workshop on Pattern Recognition, 2016.

Publication

15

Submitted to Georgia Gwinnett College

Student Paper

1 %

16

[www.thefreelibrary.com](http://www.thefreelibrary.com)

Internet Source

1 %

17

Ahmed Rubaai. "Design and Implementation of Parallel Fuzzy PID Controller for High-Performance Brushless Motor Drives: An Integrated Environment for Rapid Control Prototyping", IEEE Transactions on Industry Applications, 2008

Publication

1 %

18

[content.oss.deltares.nl](http://content.oss.deltares.nl)

Internet Source

1 %

19

[www.academypublisher.com](http://www.academypublisher.com)

Internet Source

1 %

20

Submitted to University of Southampton

Student Paper

1 %

21

[saudijournals.com](http://saudijournals.com)

Internet Source

1 %

22

[scholar.ppu.edu](http://scholar.ppu.edu)

Internet Source

1 %

23 Kanchan, R.S., K. Gopakumar, and R. Kennel. "Synchronised carrier-based SVPWM signal generation scheme for the entire modulation range extending up to six-step mode using the sampled amplitudes of reference phase voltages", IET Electric Power Applications, 2007. 1 %  
Publication

---

24 Submitted to World Maritime University 1 %  
Student Paper

---

25 [journals.sagepub.com](http://journals.sagepub.com) 1 %  
Internet Source

---

26 [www.semanticscholar.org](http://www.semanticscholar.org) 1 %  
Internet Source

---

Exclude quotes On

Exclude matches < 1%

Exclude bibliography On