

# Prosiding\_8\_ICICI\_BME.pdf

*by*

---

**Submission date:** 24-Nov-2021 01:43PM (UTC+0700)

**Submission ID:** 1711831484

**File name:** Prosiding\_8\_ICICI\_BME.pdf (1.53M)

**Word count:** 3418

**Character count:** 15229

# Modelling the Speed Control of Brushless DC Motor Base on Identification System

Hidavat<sup>1,2</sup>, Sasongko Pramonohadi<sup>2</sup>, Sariiva<sup>2</sup> and Suharvanto<sup>2</sup>

Department of Electrical Universitas Bung Hatta, Padang, Indonesia

[Tel : +681267048037; E-mail: hdyttanjung@yahoo.com]

Department of Electrical and Information Technology Universitas Gajah Mada, Yogyakarta, Indonesia

[Tel : +681313993300; E-mail: sasongko@te.ugm.ac.id]

**Abstract**-This paper presents a practice method to model the speed control of Brushless Direct Current Motor (BLDCM) system. This method only needs a dynamic response of BLDCM when given a step input. Further, the data response is represented in to the data series that used as source form the BLDCM model. BLDCM model's is generated by estimation parameter base on the least squares algorithm using that's data. Further, the model is evaluated by the MATLAB simulink and then compared by response of the real plant. The results show that the response characteristic of the speed control of BLDCM base on model is similar to the response of the real plant.

**Keyword:** BLDCM, model, estimation parameter.

## 1. INTRODUCTION

Recently, BLDCM have been widely used as motor motion in the industries, the public life, the domestic life, information and office equipment. This is caused the BLDCM has advantages than other motors, such as the efficiency is better 13 % than induction motor, the volume is smaller 40 % than conventional DC motor [1],[2]. The other advantages, caused no brush so they require little or no maintenance, they generate less acoustic and electrical noise than conventional DC motor, they can be used in hazardous operation environments (with flammable products)[3]. In spite of, the control equipment of BLDCM is still limit. As example, Atmel Corporation has produced the speed control of BLDCM using ATmega32M1 which applies a classic control that the gain tuning uses a trial and error method[3]. It can't be used to a high power BLDCM [4]. Therefore, the model of BLDCM is required to determine the controller parameter and analyze a controller's performance.

The model is representation of the behavioral system, which can be decided by two ways, such as: base on the mathematical dynamic of physical system and the system identification. The first must be known the parameter value of each element systems. In fact, not all necessary parameters that required to model are known, so it must be decided by measuring of the physical system. The equipment accurately is required to find the parameter in order to obtain the model system accurately. In spite of it is difficult required, because the measurement is limited [5].

The second, system identification is a general term used to describe mathematical tools and algorithms that build dynamical models from measured data. That data's are process variable (PV) as input and control output (CO) as input of

BLDCM that decided by the measuring [6]. In this research, it focuses on the identification of discrete-time transfer functions from the measured input and output signals.

## 1. MATHEMATICAL MODEL OF IDENTIFICATION SYSTEM

To model BLDCM base on identification system that is constructed of a mathematical description of the dynamic behavior of a system or process that emphasized on the identification of discrete-time transfer function that generated by measuring the input and output signal.

Usually, a typical discrete-time transfer function can be given by z transformation, as shown in [6].

$$G(z) = \frac{b_0 z^m + b_1 z^{m-1} + \dots + b_{m-1} z + b_m}{a_1 z^n + a_2 z^{n-1} + \dots + a_n z + a_{n+1}} z^{-d} \quad (1)$$

and it corresponds to the difference equation, as in

$$y(t) + a_1 y(t-1) + a_2 y(t-2) + \dots + a_n y(t-n) = b_1 u(t-d) + b_2 u(t-d-1) + \dots + b_m u(t-d-m+1) + \varepsilon(t) \quad (2)$$

where  $\varepsilon(t)$  can be regarded identification residual. Here the shorthand notation  $y(t)$  is used for output signal  $y(kT)$ , and  $y(t-1)$  can be used to describe the output at the previous sample, i.e.,  $y[(k-1)T]$ .

$b_i, (i = 1, \dots, m+1)$  and  $a_i, (i = 1, \dots, n), m \leq n$  are constant,  $z$  discrete variable and  $d$  delay time.

If a set of input and output signals has been measured and can be written, as in

$$u = [u(1), u(2), \dots, u(M)]^T \\ y = [y(1), y(2), \dots, y(M)]^T \quad (3)$$

From equation (3), it can be found that, as in

$$y(1) = -a_1 y(0) - \dots - a_n y(1-n) + b_1 u(1-d) + \dots + b_m u(2-m-d) + \varepsilon(1) \\ y(2) = -a_1 y(1) - \dots - a_n y(2-n) + b_1 u(2-d) + \dots + b_m u(3-m-d) + \varepsilon(2) \\ \dots \\ y(M) = -a_1 y(M-1) - \dots - a_n y(M-n) + b_1 u(M-d) + \dots + b_m u(M+1-m-d) + \varepsilon(M) \quad (4)$$

Where  $y(t)$  and  $u(t)$  assumed to be zero when  $t \leq 0$ . The matrix form of (4) can written as in

$$y = \phi \theta + \varepsilon \quad (5)$$

where

$$\phi = \begin{bmatrix} y(0) & \dots & y(1-n) & u(1-d) & \dots & u(2-m-d) \\ y(1) & \dots & y(2-n) & u(2-d) & \dots & u(3-m-d) \\ \dots & \dots & \dots & \dots & \dots & \dots \\ y(M-1) & \dots & y(M-n) & u(M-d) & \dots & u(M+1-m-d) \end{bmatrix} \quad (6)$$

$$\theta^T = [-a_1, -a_2, \dots, -a_n, b_1, \dots, b_m] \quad (7)$$

$$\varepsilon^T = [\varepsilon(1), \dots, \varepsilon(M)] \quad (8)$$

Minimize the sum of squared residual as in

$$\min_{\theta} \sum_{i=1}^M \varepsilon^2(i) \quad (9)$$

The optimum estimation to the undetermined elements in  $\theta$  can be written as in

$$\theta = [\phi^T \phi]^{-1} \phi^T y \quad (10)$$

Since the sum of squared residual is minimized, the method is also known as the least squares algorithm. The system identification to identify the discrete-time model from measured input and output data in Matlab toolbox is provided by function `arx()`. If the measured input and output signals are expressed by column vectors  $u$  and  $y$  the orders of the numerator and denominator as assumed to be  $m-1$  and  $n$ , respectively, and the delay term is  $d$ , the following statement can be used, as in

$$H = arx([y, u], [n, m, d]) \quad (11)$$

In this case, input is a control input and an actual speed that can be obtained by measuring dynamic speed response of BLDCM.

### III. HARDWARE SYSTEM DESCRIPTION

BLDCM is constructed of the Permanent Magnet Synchronous Machine (PMSM) 3 phase star connection, 2 poles, a AC source and rectifier, a rotor position sensor, 3 phase inverter and an algorithm control [7],[8], as shown in Fig.1. In practice, a BLDCM have been completed by two elements which generally consist of two parts of separate elements, such as a BLDCM driver and a BLDCM.

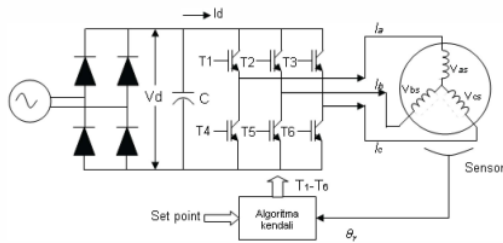

Fig.1. The circuit element of BLDCM

The hardware apparatus for speed control BLDCM is composed of four major elements: an ARM Cortex-M3 board, a controlled process (BLDCM ZW60BL120-430 with PM dc generator as dynamic load), a BLDCM driver 10/50DPW15B and a speed sensor. The ARM Cortex-M3 chips type STM32 F103RB M3 32 bit speed 72 MHz [9] that forms the core of the closed loop system. Aside from the duties of controlling the operator interface, it performs the acquisition of the feedback

signal, computes an error signal, delivers the error signal to the control algorithm, and executes the control algorithm to determine a control signal. The control algorithm is built within C programming on notebook, and then uploading to ARM Cortex-M3.

BLDCM that will be determined the model is BLDCM ZW60BL120-430 type, which was manufactured by Jinan Keya Electronic Co. LTD [10].

P = 250 W  
N = 3000 Rpm  
V = 48 V  
I = 7 A  
Pole = 2

The BLDCM is also coupled with PM dc generator instead of a dynamic load.

The 10/50DPW15B motor driver board is manufactured by Jinan Keya Electronic Co. LTD. It provides an analogue set value input 0 – 5V thus results 3 phase ac voltage output 10 – 50 V for dc voltage input 50 V [10].

The process variable is a speed that measured by speed sensor. In this case, a speed sensor can be built with useful rotor position sensor signal ( $H_1, H_2, H_3$ ), which built in a BLDCM. In addition to a signal conditioner circuit, can be obtained a speed information of BLDCM as shown in Fig.2. It consists of two ex-or gates and f/v converter circuit (IC LM331). A speed sensor output is an analogue signal 0 – 5 V that the equivalent of speed 0 – 3000 Rpm.

An auxiliary equipment is notebook Intel Pentium Dual CPU T2330 @ 1.60 GHz with Windows XP that used as a program design, set data input and modeling. The others, stored oscilloscope is used as a display of signal. Fig.3 shows a photo of the experimental apparatus and then simplified to be block diagram of the BLDCM speed control system, as shown in Fig.4.

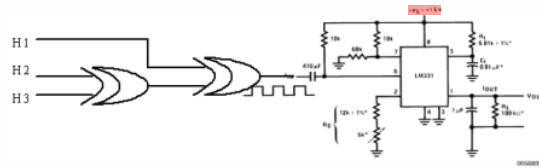

Fig.2. The signal conditioner and f/v circuit



Fig.3. Photograph of the experimental apparatus.

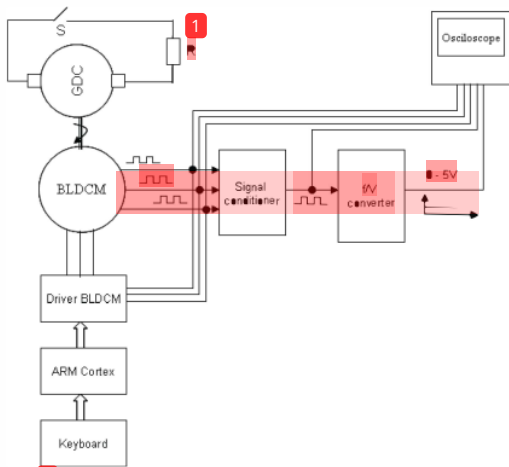

Fig. 4. The block diagram of the BLDCM speed control system

#### IV. EXPERIMENTAL RESULTS

In this research, some experiment was being done to obtain the model speed control of BLDCM drive system that divided by three steps. The first is measuring of the element system consist of speed sensor, dynamic response of BLDCM. The second is modelling using MATLAB simulink base on the least squares algorithm. The third evaluated and analysed the model has been resulted. It is done by compared the results of a response base on model with the real response of a BLDCM

##### A) Experimenting on sensor

Experimenting on sensor according Fig. 2 and Fig.4 consists of measuring the signal output of rotor position sensor ( $H_1, H_2, H_3$ ) use a storage oscilloscope that used as the input of speed sensor. The result is, as shown in Fig. 5. There are three square signals that different  $120^\circ$  each others. The input and output signal condition circuit and f/v converter is shown in Fig.6.

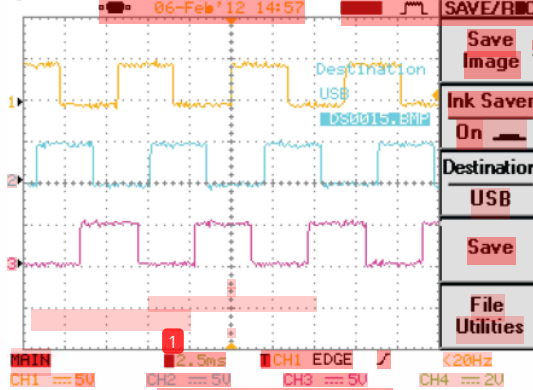

Fig.5. The input of a speed sensor

1  
A green square signal is an output of signal conditioner and then as input of f/v converter. A yellow signal is output of the f/v converter that represents a speed of BLDCM.

Determining the characteristic of a speed sensor is desired to find the relation a control signal ( $u$ ) with a speed of BLDCM (process variable,  $y$ ) that obtained by measuring an output voltage of LM 331 (f/v converter). It is done by giving the step by step voltage to BLDCM winding to throw the controller input signal on ARM Cortex 200-65000 in decimal value. The characteristic speed sensor of BLDCM is shown by Fig. 6, where the output voltage 1,2 to 3,1 V is liner with a speed on 700 to 2000 Rpm. Therefore, the operating area of sensor is when a speed of BLDCM 700 to 2000 Rpm

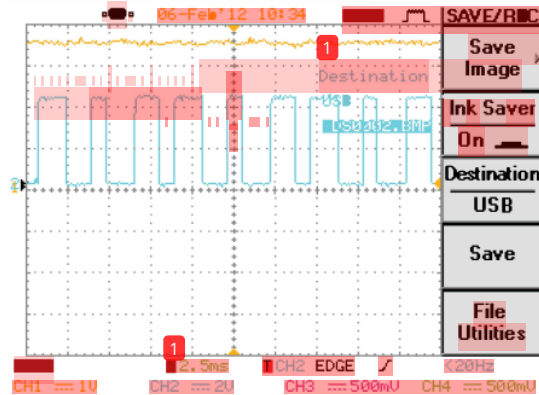

Fig.6. The output signal of a speed sensor

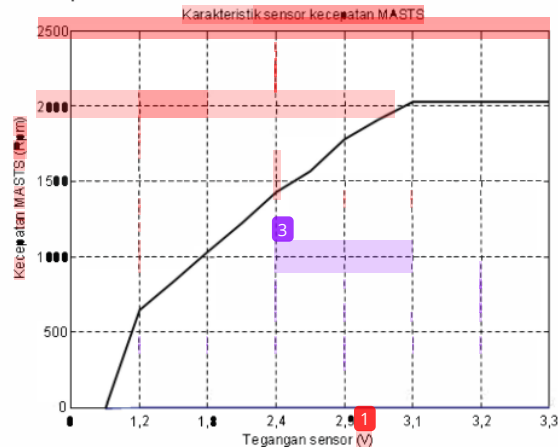

Fig.7. The characteristic speed sensor of BLDCM

##### B) Experimenting on dynamic response

The dynamic response can be obtained by giving a step input throw ARM Cortex (50000 decimal) and then BLDCM is started. The dynamic speed response of BLDCM is shown and saved by storage oscilloscope as showed in Fig. 8. The transient parameter such as;  $t_d=0,6$ sec,  $t_r=t_s=1,3$  sec, time

constant = 0,6 sec,  $d Mp=0\%$ . The storage oscilloscope also gives the numeric series data that according to the dynamic speed response. To model the speed control of BLDCM is required three series data, such as; time (t), actual speed (y(t)) and control input (u(t)). According to measuring result by storage oscilloscope is obtained y(t) and t, while u(t) is the step input that given. The series data in Fig.8 is showed in Table 1.

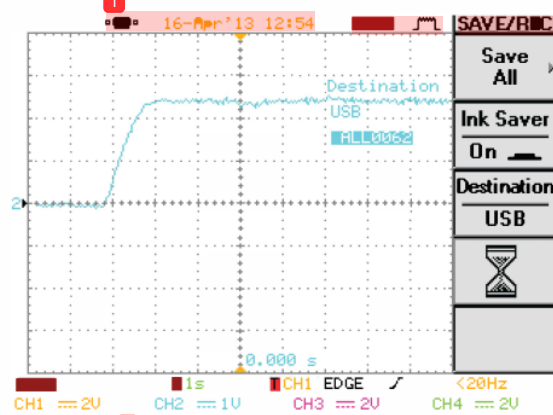

Fig.8. The dynamic response of BLDCM drive system base on measuring

By using MATLAB programming has been given in (11) and given  $n = 2$ ,  $m = 2$  and  $d = 0,001$ . The data  $y(t)$  and  $u(t)$  are written on the command window MATLAB, thus the statement to identification parameter too.

$$H=arx([y,u],[2,2,0.001]) \quad (11)$$

After program is run, obtained the model of speed control of BLDCM forming the discrete transfer function, as in

$$TF = \frac{0,05136z + 0,07078}{z^2 - 0,0573z - 0,03198} \quad (12)$$

The transfer function that shown above is model of BLDCM drive system that including DC generator as the dynamic load. The numerator and denominator of transfer function a above respectively orde 1 and orde 2. It is correspond to the dynamic response of BLDCM drive sistem base on measuring that shows the first order plus dead time (FOPDT).

### C) Experimenting on model simulation

The model that has been obtained further evaluated and analyzed by MATLAB simulink. The simulation circuit as shown in Fig.9. By giving the step control signal 70, thus program is run. The result of dynamic response can be seen in Fig.10.

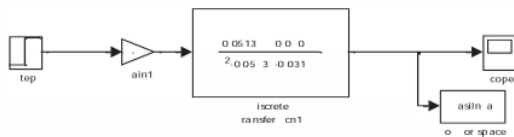

Fig.9. The simulation circuit for speed control of BLDCM

TABLE I. THE SERIES DATA OF DYNAMIC SPEED RESPONSE OF BLDCM

t	y(t)	u(t)	t	y(t)	u(t)	t	y(t)	u(t)	t	y(t)	u(t)	t	y(t)	u(t)
0	0	70	0,56	50	70	1,12	74	70	1,68	73	70	2,24	70	70
0,02	-1	70	0,58	49	70	1,14	73	70	1,7	73	70	2,26	72	70
0,04	-2	70	0,6	50	70	1,16	75	70	1,72	74	70	2,28	70	70
0,06	-2	70	0,62	52	70	1,18	73	70	1,74	74	70	2,3	72	70
0,08	2	70	0,64	53	70	1,2	70	70	1,76	72	70	2,32	70	70
0,1	5	70	0,66	54	70	1,22	75	70	1,78	73	70	2,34	70	70
0,12	6	70	0,68	57	70	1,24	72	70	1,8	74	70	2,36	70	70
0,14	6	70	0,7	57	70	1,26	71	70	1,82	73	70	2,38	71	70
0,16	11	70	0,72	59	70	1,28	74	70	1,84	73	70	2,4	71	70
0,18	14	70	0,74	62	70	1,3	72	70	1,86	74	70	2,42	74	70
0,2	14	70	0,76	60	70	1,32	72	70	1,88	73	70	2,44	73	70
0,22	21	70	0,78	61	70	1,34	72	70	1,9	73	70	2,46	74	70
0,24	19	70	0,8	62	70	1,36	70	70	1,92	74	70	2,48	74	70
0,26	20	70	0,82	61	70	1,38	72	70	1,94	74	70	2,5	74	70
0,28	25	70	0,84	66	70	1,4	73	70	1,96	73	70	2,52	73	70
0,3	25	70	0,86	67	70	1,42	70	70	1,98	74	70	2,54	74	70
0,32	30	70	0,88	65	70	1,44	72	70	2	74	70	2,56	74	70
0,34	33	70	0,9	70	70	1,46	71	70	2,02	71	70	2,58	72	70
0,36	36	70	0,92	68	70	1,48	74	70	2,04	74	70	2,6	74	70
0,38	37	70	0,94	69	70	1,5	71	70	2,06	73	70	2,62	74	70
0,4	36	70	0,96	72	70	1,52	73	70	2,08	71	70	2,64	74	70
0,42	36	70	0,98	69	70	1,54	73	70	2,1	74	70	2,66	73	70
0,44	40	70	1	72	70	1,56	73	70	2,12	72	70	2,68	74	70
0,46	44	70	1,02	71	70	1,58	72	70	2,14	71	70	2,7	73	70
0,48	45	70	1,04	71	70	1,6	73	70	2,16	73	70	2,72	71	70
0,5	46	70	1,06	71	70	1,62	72	70	2,18	69	70	2,74	74	70
0,52	45	70	1,08	74	70	1,64	72	70	2,2	71	70	2,76	71	70
0,54	46	70	1,1	74	70	1,66	72	70	2,22	73	70	2,78	69	70

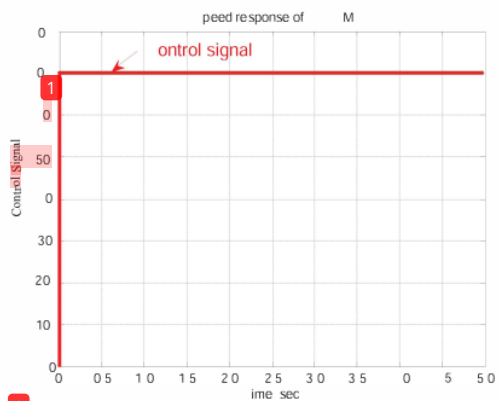
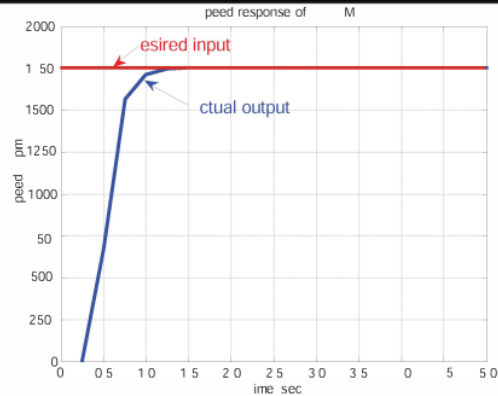

Fig.10. The dynamic response of BLDCM speed drive base on model

1  
According to Fig.10 is obtained the transient parameter such as;  $t_d=0,6$  sec,  $t_r = t_s=1,3$  sec, time constant = 0,6 sec, and  $M_p= 0\%$ . Comparing the transient parameter of measuring result with transient parameter of modeling result the BLDCM drive system is obtained the similar value.

#### V. CONCLUSION

Modeling of the BLDCM drive system accurately can be done by identification system. The main factor to determine model accurately is acquired by how to accurate the equipment of measuring. The model can be used as design and evaluate of the performance control of plant.

#### REFERENCES

- [1]. Gieras, J.F, Wing.M, Permanent Magnet Motor Technology Design & Application, 2<sup>nd</sup> Edition, Printed USA, London UK, 2002.
- [2]. Hidayat, Sasongko.PH, Srijiya and Suharyanto, "The Speed and Torque Control Strategy of the Brushless DC Machine", CITEE 2010, Yogyakarta, 20 Juli 2010.
- [3]. Atmel Corporation, "Brushless DC Motor Control Using ATmega 32M1" April 2008
- [4]. Hidayat, PH.Sasongko, Sarjiya & Suharyanto, "Modeling and Simulation of Adaptive Neuro Fuzzy Inference Systems (ANFIS) for Speed Control 1 Brushless DC Motor", Proc. CITEE 2011, Yogyakarta, 28 Juli 2011, paper E-4-1
- [5]. Douglas J.C, "Process Data, Dynamic Modeling and a Recipe for Profitable Control", 2009. <http://www.controlguru.com/wp/p35.html>
- [6]. Xue.D, Chen.Y and Atherton.P.D, "Linier Feedback Control Analysis and Design with MATLAB, Philadelphia, 2007.
- [7]. Krause, Paul.C, " Analysis of Electric Machinery And Drive Systems", IEEE Press, 2<sup>nd</sup> Edition, USA, 2002.
- [8]. Hidayat, PH.Sasongko, Sarjiya & Suharyanto, " Performance Analysis of Adaptive Neuro Fuzzy Inference Systems (ANFIS) for Spe 1 Control of Brushless DC Motor, in Proc. ICEE 2011, 17-19 July 2011, p. 211.
- [9]. Widyanto, 2010. Introducing ARM CortexM0, <http://www.kelas-mikrokontrol.com/e-learning/mikrokontroler/mengenal-arm-cortex%20Adm0.html>
- [10]. Jinan Kenya Electronic, "Operating Instruction BLDCM Motor Control, Cina, 2009.

ORIGINALITY REPORT

---

73%

SIMILARITY INDEX

26%

INTERNET SOURCES

72%

PUBLICATIONS

9%

STUDENT PAPERS

---

PRIMARY SOURCES

---

1	Hidayat, Sasongko Pramonohadi, Sarjiya, Suharyanto. "Modelling the speed control of Brushless DC Motor base on identification system", 2013 3rd International Conference on Instrumentation, Communications, Information Technology and Biomedical Engineering (ICICI-BME), 2013 Publication	69%
2	Submitted to School of Business and Management ITB Student Paper	2%
3	<a href="http://www.physionet.org">www.physionet.org</a> Internet Source	1%
4	<a href="http://vdocuments.site">vdocuments.site</a> Internet Source	1%
5	"Front matter + ToC", 2013 3rd International Conference on Instrumentation, Communications, Information Technology and Biomedical Engineering (ICICI-BME), 2013 Publication	<1%

---

---

Exclude quotes Off

Exclude matches Off

Exclude bibliography Off